



**SQC Series**  
Owner's Manual

This Manual is for the Installation, Operation,  
and Maintenance of the

**WATER FACTORY SYSTEMS®**

SQC Series  
Reverse Osmosis (RO) Drinking Water Appliance

# INTRODUCTION

This manual explains the installation, operation and maintenance of the Water Factory Systems® SQC Series Reverse Osmosis (RO) Drinking Water Appliances. Please read each section of this manual carefully. The specific model chosen should be appropriate for the local water conditions and the customer's needs. Check the Performance Data Sheet for the performance characteristics and the conditions of use.

The Water Factory Systems undercounter RO drinking water appliances are designed to connect permanently to a home plumbing system. To ensure that the installation conforms to your state and local plumbing codes, it is recommended that the installation be performed by a qualified installation specialist for RO drinking water appliances or a licensed plumber. Failure to install the system as instructed will **VOID** the warranty.

**Caution: The RO membrane cartridge is shipped with a preservative solution inside. Make sure to flush it thoroughly as directed before the first use.**

## TABLE OF CONTENTS

### I. Installation Instructions

A.	Determine the appliance location.....	3
B.	Prepare the area for installation.....	3
C.	Prepare the appliance for installation.....	4
D.	Make the faucet mounting hole .....	4
E.	Mount the faucet.....	5
F.	Install the feed water tapping valve and tubing .....	6
G.	Prefill and sanitize the storage tank .....	7
H.	Install the drain connection .....	7
I.	Install the purification assembly and storage tank .....	8
J.	Make the tubing connections .....	8
K.	Install the icemaker hookup (optional) .....	8
L.	Start up the appliance .....	8
M.	Flush the appliance of the preservative and check the operation .....	9
N.	Cleanup & paperwork.....	9
O.	Appendix for basement installations .....	11
P.	Installation troubleshooting.....	12

### II. Operation & Maintenance Instructions

A.	Important water quality assurance requirements .....	13
B.	Replacing the filter cartridges.....	13
C.	Replacing the RO membrane cartridge .....	13
D.	Sanitizing the RO appliance.....	14
E.	Long term non-use .....	15



# I. Installation Instructions

## A. DETERMINE THE APPLIANCE LOCATIONS

The appliance can be located under a sink or in a basement depending on space availability and the customer's preference. If a basement installation is selected, additional tubing, hardware and fittings may be needed and a hole will have to be made from inside the cabinet, through the floor, to the basement. Never install it in an area of the home where the temperature may drop to freezing, because damage to the appliance may occur.

The exact placement of the various components of the appliance will vary from installation to installation. The installer, in conjunction with the customer, must decide on where to place the faucet, tank and purification assembly by balancing the homeowner's convenience with ease of installation and servicing. (See Fig. 1 & 7)

Considerations for an icemaker or other remote hookup should be predetermined, including routing and any additional tools, fittings, and tubing that may be required.

## B. PREPARE THE AREA FOR INSTALLATION

Remove supplies from under the sink and stack them neatly away from the working area. Arrange a light for the work area, if necessary.

If a basement installation is called for, determine where the components will be located and how they will be mounted. Special mounting brackets and hardware may be necessary to secure the appliance to a wall or ceiling joists.

Inspect the cold water supply line and determine if any special fittings, in addition to what is included in the kit, are required.

**NOTE:** It is a good idea at this time to check the condition of the undercounter plumbing for any existing or potential leaks. Make sure to perform any necessary repairs prior to the installation of the drinking water device.

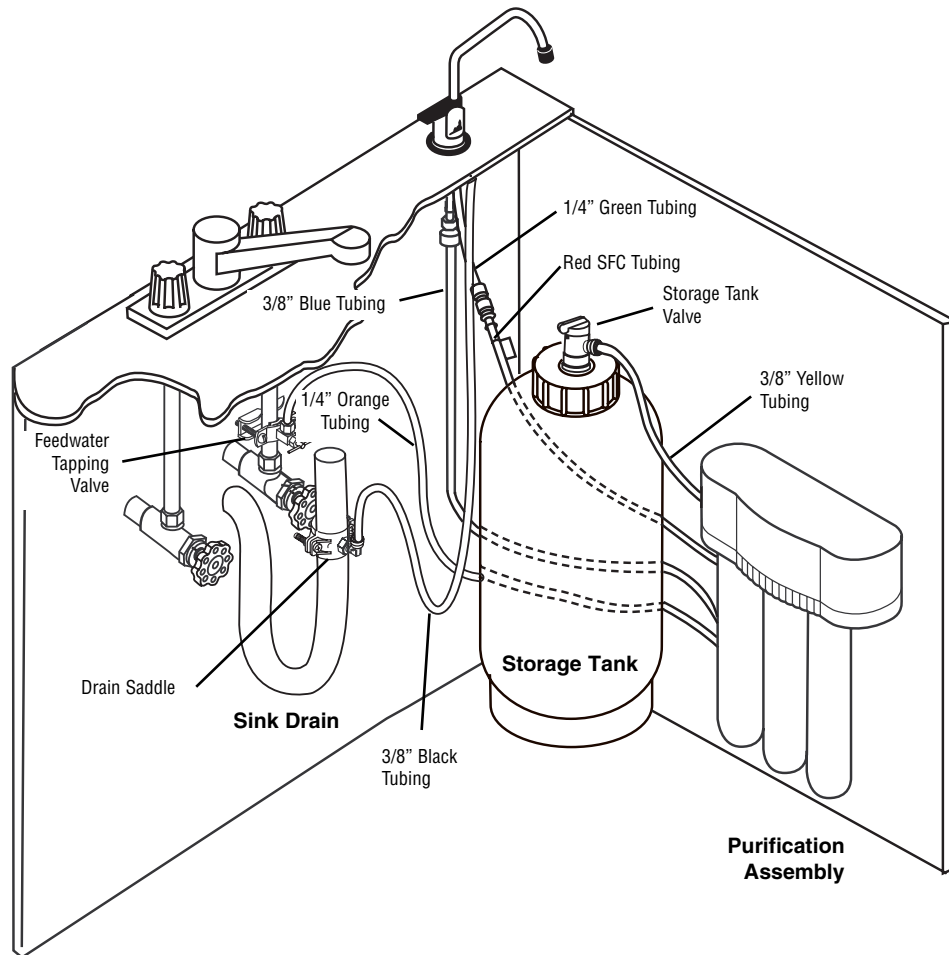

Fig. 1

### C. PREPARE THE APPLIANCE FOR INSTALLATION

Open the shipping carton and remove the components. Check to see that all of the installation parts are present. They should include the purification assembly, storage tank, faucet, installation hardware, RO membrane cartridge and tubing. Check to see that the air supply in the empty tank is approximately 7 psi (48 kPa). Adjust it if necessary. If an optional percent rejection monitor is selected, the probes should be installed at this time. Follow the instruction that came with the monitor. To ensure you the highest level of purity, the RO membrane cartridge has been shipped separately in a sealed plastic bag. Follow the steps below to install the RO membrane cartridge.

STEP 1: Cut open the sealed plastic bag and remove the RO membrane cartridge.

STEP 2: Remove the white plug from the fitting at the bottom of the cartridge by pushing in the small gray collet and pulling out the plug simultaneously (see Figure 6).

STEP 3: Connect the red SFC reject tubing by inserting the open end into the fitting at the bottom of the RO membrane cartridge as far as it will go. Take note of the tag attached to the SFC tube which indicates the outlet end.

STEP 4: Remove the red plastic cap from the top of the cartridge.

STEP 5: Line up the cartridge ears (Fig. 10), insert the cartridge and push it into the head until it is fully seated. Twist the cartridge 1/4 turn counterclockwise to lock it into place. The final orientation should be such that the cartridge label faces towards the front and the fitting is located towards the rear.

### D. MAKE THE FAUCET MOUNTING HOLE

A wide variety of RO faucet mounting situations may be encountered. The most common are stainless steel or ceramic on metal sinks. Consult your dealer for any other materials which may be encountered.

The faucet should be positioned so that it empties into the sink and the spout swivels freely for convenience.

If the sink already has a hole provided that can accommodate the RO faucet, then no drilling is required.

**NOTE:** If desired, sprayers can be disconnected to provide a suitable mounting hole for the RO faucet. A pipe cap or plug will be required to seal the sprayer connection.

**IMPORTANT:** It is mandatory that safety glasses be worn during the sink hole drilling operations in order to prevent eye injury.

Before drilling the hole, always check underneath the sink to ensure that nothing will interfere with mounting the faucet such as reinforcing ribs, support brackets or the cabinet construction.

#### Stainless steel sink, air gap or non-air gap faucet.

Recommended tools:

- Center punch
- Variable speed drill and high speed drill bits
- Greenlee 7/8" chassis punch (alternate 9/16" may be used for a non-air gap faucet)
- Protective gloves

#### Procedure:

- 1) Center punch a small indent at the center of the desired faucet location.
- 2) Slowly drill the required pilot hole for the chassis punch.
- 3) Set up the chassis punch per the instructions and tighten the nut to cut the desired hole size.
- 4) Clean up all sharp edges with a file if necessary.

#### Porcelain/Enamel/Ceramic sink on sheet metal or cast iron base; air gap or non air gap faucet.

Recommended tools:

- Variable speed drill
- Relton 7/8" porcelain cutter tool set (alternate 9/16" porcelain bit may be used for a non-air gap faucet)
- Plumber's putty

It is important to understand what is involved in this procedure. First, the glassy layer of porcelain must be penetrated through to the base metal. Second, a center disc of porcelain must be removed while protecting the surrounding porcelain against chipping or fracturing. Third, the base metal must be drilled through to complete the hole.

#### Procedure:

- 1) Mark the center for the 7/8" hole.
- 2) Form a shallow putty dam around the hole area and fill it with enough water to lubricate the carbide drill bit.
- 3) Carefully drill a pilot hole through the porcelain/enamel and the base metal using a carbide type pilot drill.

**Important:** Always operate the drill with light pressure at a slow speed (300-400 rpm).

- 4) Insert the pilot tip of the spring-loaded porcelain cutter into the pilot hole.
- 5) Drill the porcelain/enamel using the spring-loaded porcelain cutter, making certain a complete ring has been cut through the porcelain/enamel to the metal base.
- 6) Change to the metal cutter. With a slow speed and light pressure, cut away the inner porcelain/enamel disc down to the base metal. Make certain that the cutter does not touch the outer rim of the cut porcelain/enamel. Continue with this bit to cut completely through the metal.

**IMPORTANT:** When using a porcelain cutter it is critical that it is always in a sharpened condition. Dull cutters are known to chip sinks.

## E. MOUNT THE FAUCET

Undercounter installations generally require that the faucet's built-in air gap be used. In basement installations, the built-in air gap does not have to be used if one is provided elsewhere on the drain line.

### For Basement Installations Without An Air Gap Module See Installation Instructions O.

**IMPORTANT:** The Uniform Plumbing Code dictates that there must be an air gap between the RO reject line and the waste drain. An optional non-air gap faucet, which requires a smaller 9/16" mounting hole, is available to make basement installations easier.

### Undercounter Installation With An Air Gap Faucet:

- 1) Familiarize yourself with all of the components shown in the air gap faucet diagram. (See Fig. 2)
- 2) Remove the hardware from the threaded nipple of the faucet, except for the chrome base plate and the rubber washer. The rubber washer may be replaced with a bead of plumber's putty for a neater appearance.

- 3) Connect the 1/4" green tubing supplied in the installation kit to the smaller barb on the air gap faucet. Push it on firmly until it seats.
- 4) Connect the 3/8" black tubing to the larger barb on the air gap faucet. Push it on firmly until it seats.
- 5) From above the sink counter-top, feed the air gap tubing and the threaded nipple through the faucet mounting hole and position the faucet spout over the sink.
- 6) From below the sink/countertop, install the white spacer (open side toward the air gap tubing), flat washer and hex nut onto the threaded nipple and tighten it by hand.
- 7) Back off on the hex nut just enough to slide the slotted washer (open side toward the air gap tubes) between the white spacer and the underside of the sink/countertop.
- 8) After rechecking the faucet orientation, tighten the hex nut with a 9/16" wrench until the faucet feels secure.
- 9) From above the sink, make any minor orientation corrections by turning the faucet on its flats with a padded adjustable wrench. Use care so as not to mar the chrome finish.

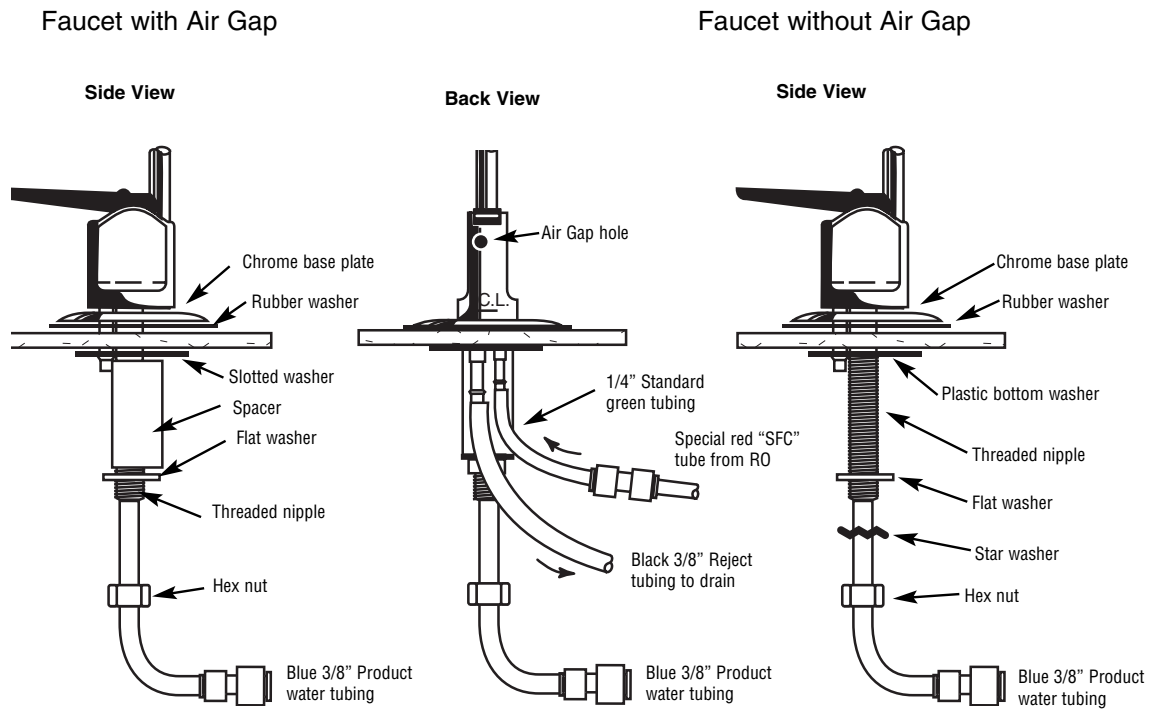

Fig. 2

## F. INSTALL THE FEED WATER TAPPING VALVE AND TUBING

The feed water tapping valve which is supplied, is designed to be used on 3/8" to 1/2" OD soft copper tubing (plain or chromed) and rigid metal pipe. Do not use it on flexible ribbed tubing, because it has too thin a wall thickness and it requires special hardware.

### Soft Copper Tubing Installation:

- 1) Close the cold water supply valve under the sink, or the main valve for the house.
- 2) Before installing the feed water tapping valve, make sure that the piercing lance does not protrude beyond the rubber gasket. (See Fig. 3)
- 3) Assemble both halves of the feed water tapping valve onto the copper tubing.
- 4) For 3/8" OD tubing, use the side of the bracket with the projections to prevent distortion of the tubing. Use the "V" side of bracket for all larger size tubing. Tighten the screws evenly and firmly. The brackets should be parallel. Do not deform the tubing. (See Fig. 3)
- 5) To pierce the soft copper tubing, turn the handle clockwise until it is firmly seated. The valve is closed in this position. With a wrench, tighten the nut/seal around the valve handle stem. Open the cold water supply valve.
- 6) Remove the cover from the appliance and disconnect the orange 1/4" tubing from the feed water fitting. (See Fig. 6)
- 7) Connect one end of the orange tubing to the feed water tapping valve using the brass compression nut, insert in plastic sleeve. (See Fig. 3)

**NOTE:** For basement installations, the existing orange feed water tubing may have to be longer to reach the feed water tapping valve.

**IMPORTANT:** Some local plumbing codes may prohibit the use of saddle-type valves and/or drain connections. States prohibiting the use of saddle valves are Alaska, Delaware, Idaho, Kentucky, Massachusetts, Michigan, Minnesota, New Hampshire, North Dakota, Ohio, and South Dakota. Check your local plumbing codes for any restrictions that apply. Massachusetts CMR 248 strictly prohibits the use of saddle-type valves. The feed water connection must conform to applicable plumbing codes.

### Rigid Metal Pipe Installation:

- 1) Close the cold water supply valve and drain the line to prevent spillage.
- 2) Drill a 3/16" diameter hole at the desired location on the pipe. To prevent any electrical shock hazard, use a battery operated drill.
- 3) Turn the feed water tapping valve handle clockwise to expose the piercing lance beyond the rubber gasket no more than 3/16". (See Fig. 3)
- 4) Assemble the feed water tapping valve on the pipe by inserting the piercing lance into the drilled hole and tightening the two halves together. Use the "V" side of the bracket. Tighten the screws evenly and firmly, keeping the two sides of the bracket parallel.
- 5) Turn the feed water tapping valve handle clockwise to close the valve. With a wrench, tighten the nut/seal around the valve handle stem.
- 6) Remove the cover from the appliance and disconnect the orange 1/4" tubing from the feed water fitting. (See Fig. 6)
- 7) Connect one end of the orange tubing to the feed water tapping valve using the brass compression nut, insert, and plastic sleeve. (See Fig. 3)

**NOTE:** For basement installations, the existing orange feed water tubing may have to be longer to reach the feed water tapping valve.

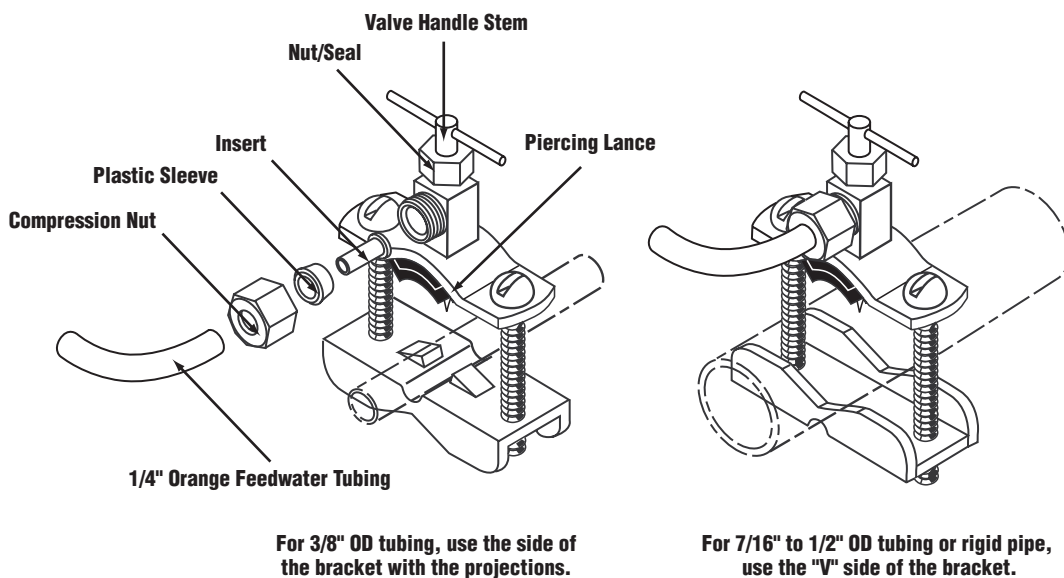

Fig. 3

## G. PREFILL AND SANITIZE THE STORAGE TANK

Prefilling the storage tank is always recommended so that there is pressure to check for leaks as well as sufficient water to flush the carbon postfilter. The SQC RO Drinking Water Appliance is furnished with a container of special sanitizing granules. It is important to use a sanitizer when prefilling the tank.

- 1) Thread the taped 3/8" x 1/4" tank fitting into the tank valve. Do not over tighten. Open the tank valve so that the tank valve handle is parallel to the valve body. Locate the enclosed container of sanitizing granules, open it and pour the contents into the end of the tank valve.
- 2) Disconnect the 3/8" yellow tubing from the back of the purification assembly and connect one end of it into the tube fitting located on the tank valve.
- 3) Connect the other end of the 3/8" yellow tubing to the 3/8" x 1/4" union connector included in the tank sanitization kit.
- 4) Connect the free end of the 1/4" orange feed water tubing to the other end of the 3/8" x 1/4" union connector.
- 5) Open the feed water tapping valve (making sure the tank valve is still open) and allow the tank to fill (about 3 minutes).
- 6) Close the feed water tapping valve and the tank valve. Disconnect the 3/8" yellow tubing from the tank valve elbow fitting and set the tank aside while proceeding with the rest of the installation (the sanitizing solution should be kept in the tank for at least 15 minutes).

**NOTE:** If you encounter difficulty in removing the tubing from the tank, make sure the tank valve is closed and then cut the yellow tubing approximately 1" away from the tank valve fitting to relieve the pressure. Remove the 1" piece from the tank fitting.

**NOTE:** If an alternate storage tank is used, it should be sanitized with household bleach (5-1/4%). Use 3 ml. (1/2 teaspoon) of bleach for a 2.5 gallon tank.

- 7) Reconnect the 3/8" yellow tubing to the back of the purification assembly. Reconnect the 1/4" orange tubing to the feed water fitting on the purification assembly.

**IMPORTANT:** After the installation is complete, it is recommended that the 3/8" x 1/4" union connector be saved for future use in tank sanitization.

## H. INSTALL THE DRAIN CONNECTION

**IMPORTANT:** Before starting this procedure, inspect the condition of the drain piping, especially in older homes where the traps and tailpieces can be deceptively thin and frail. If they are in poor condition, it is wise to inform the customer that the condition should be remedied.

**IMPORTANT:** Some local plumbing codes may prohibit the use of saddle-type valves and/or drain connections. The use of saddle-type valves are prohibited in Alaska, Delaware, Idaho, Kentucky, Massachusetts, Michigan, Minnesota, New Hampshire, North Dakota, Ohio, and South Dakota. Check your local plumbing codes for any restrictions that apply. Massachusetts CMR 248 strictly prohibits the use of saddle-type valves. The feed water connection must conform to applicable plumbing codes.

### Undercounter Installation:

The drain saddle assembly is designed to fit around a standard 1-1/2" OD drain pipe. For smaller (lavatory type) or larger (ABS pipe) drains, consult your dealer for special drain saddles.

The drain saddle should always be installed above (before) the trap and on the vertical or horizontal tailpiece. Never install the drain saddle close to the outlet of a garbage disposal because plugging of the RO drain line may occur. (See Fig. 4)

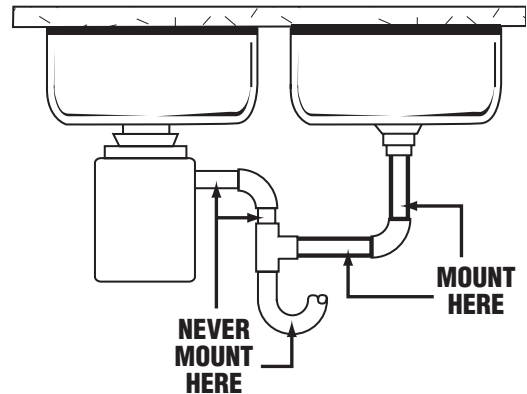

Fig. 4

- 1) Position the threaded half of the drain saddle at the selected location and mark the pipe through the threaded opening.
- 2) Drill a 1/4" hole at the marked location through one side of the drain tailpiece.
- 3) Position both halves of the drain saddle on the drain pipe so that the threaded opening is lined up with the hole in the drain pipe.
- 4) Use the screws and nuts to clamp the drain saddle onto the drain pipe. Make sure that there is equal space between saddle halves on each side. Do not overtighten. (See Fig. 5)
- 5) Orient the elbow in the direction of the RO faucet location.

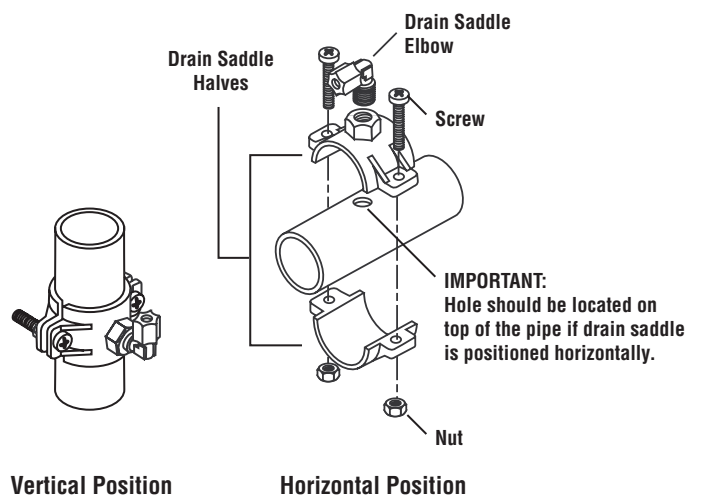

Fig. 5



## I. INSTALL THE PURIFICATION ASSEMBLY AND STORAGE TANK

For Basement Installation See Installation Instructions O.

### Undercounter Installation:

The purification assembly is usually mounted to the right or the left side wall inside of the sink cabinet, taking into consideration the space available and the tank location. Generally, the storage tank is placed in the rear of the sink cabinet while the purification assembly is positioned toward the front for filter cartridge accessibility.

To mount the purification assembly, elevate it at least 2" (5 cm) off of the cabinet floor and, while keeping it level, mark the location of the mounting holes on the cabinet side wall. Make small pilot holes with an awl or a drill and screw in the two mounting screws; leaving just enough protruding to allow the bracket mounting slots to slide over them.

**NOTE:** If the cabinet side walls are not of solid construction, the purification assembly can be set on the cabinet floor and held against the side wall with the mounting screws. However, the purification assembly will then need to be lifted from the mounting screws in order to remove the filter cartridges.

The storage tank may be oriented either vertically or horizontally. It is generally placed to the rear of the cabinet but can be set in the front center (between the sink basins) for ease of access if space permits. For horizontal positioning, carefully detach the tank base from the tank bottom and use it as a cradle.

## J. MAKE THE TUBING CONNECTIONS

With all of the components in place, the tubing connections can be made. When routing the tubing between the components, several guidelines should be observed.

- Tubing runs should generally follow the contour of the cabinet rather than interfere with the cabinet storage area.
- Strive for a neat and orderly tubing "flow" by using fasteners (e.g. insulated staples) to secure the tubing.
- Arrange the tubing so that there are no sharp bends. Leave some "play" in the tubing for ease of servicing, then cut the tubing to the desired length.
- Try to keep the tubing from the purification assembly to the tank and faucet as short as practical for good flow.

For Basement Installation See Installation Instructions O.

### Undercounter Installation:

The appliance will have the 3/8" yellow, 3/8" blue and the special red SFC tubing already connected to the purification assembly.

- 1) The 1/4" orange tubing should already have been connected to the feedwater tapping valve. Route the other end through the large opening in the bottom of the metal bracket and loop it back to the "Feed" connection on the purification assembly.
- 2) Attach the 1/4" x 3/8" union to 1/4" blue tubing on faucet.
- 3) Connect the 3/8" blue tubing from the purification assembly to the other end of 3/8" x 1/4" union.
- 4) Route the 3/8" black tubing from the faucet air gap to the drain saddle so that it slopes continuously downward without any loops or low spots. Cut the tubing to the proper length and connect it to the drain saddle elbow.

- 5) Connect the 3/8" yellow tubing from the purification assembly to the tank.
- 6) Route the special red SFC tubing toward the faucet. **Do not cut this special SFC tubing.** It's length is important to maintain proper efficiency and performance.
- 7) Cut the 1/4" green tubing from the faucet air gap to the proper length and connect it to the 1/4" connector fitting on the end of the SFC tubing.

## K. INSTALL THE ICEMAKER HOOKUP (optional)

The RO drinking water appliance can be connected to any standard refrigerator icemaker or icemaker/water dispenser. It should never be connected to a commercial type bar icemaker.

Hooking up an icemaker involves connecting a tee with a shut off valve into the 3/8" blue faucet tubing and routing the tubing over to the refrigerator. Hooking up to existing copper unit is generally not recommended unless it is less than six months old. If copper tubing must be used, then the installation of a small in-line carbon filter at the refrigerator connection is recommended.

Before turning off the existing tap water supply to the refrigerator icemaker, always shut off the icemaker first (usually by lifting the lever arm above the bin to the uppermost position).

The icemaker should only be turned on again **after** the RO system has been drained several times and the storage tank has a **full** supply of water.

**NOTE:** Contact your dealer for the availability of special icemaker hookup kits.

**IMPORTANT: Before any service is performed on the RO appliance, always turn off the icemaker valve and the icemaker unit. Only turn them on when the system is operating and the tank is full.**

## L. START UP THE APPLIANCE

- 1) Double check to see that all of the connections are secure.
- 2) Open the feed water tapping valve and check the appliance for leaks. If any leaks are detected, close the valve and correct the problem before proceeding.

**NOTE:** If a leak occurs at a "Push In" plastic fitting, then refer to Fig. 6.

- 3) Open the storage tank valve and lift the faucet handle until a steady stream of water flows. Close the faucet, wait at least 5 minutes and carefully check for leaks. Correct them as necessary.

**NOTE:** When the appliance is first turned on, water may intermittently "spurt" from the air gap opening at the side of the faucet. This is perfectly normal, and is caused by air trapped in the system. This will usually disappear within a short time.

## 'Push-In' Tubing Connector

This product is outfitted with user friendly 'Push In' connectors. Proper use of the connectors is shown in the diagrams.

It is most important that the tubing selected for use with these connectors be of high quality, exact size and roundness, and with no surface nicks or scratches. If it is necessary to cut the tubing, use a plastic tubing cutter or sharp razor knife. Make a clean square cut.

Should a leak occur at a 'Push-In' connector, the cause is usually defective tubing.

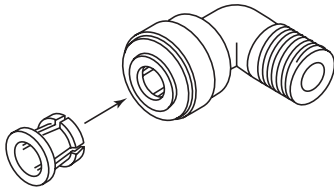

- To Fix:
- Relieve pressure
  - Release tubing
  - Cut off at least 1/4" from end.
  - Reattach tubing
  - Confirm connection is leak free.

### To Attach Tubing

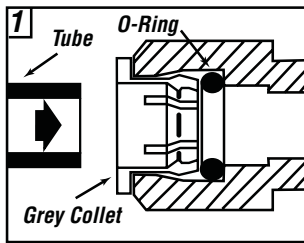

Push tubing straight in as far as it will go. Tubing is secured in.

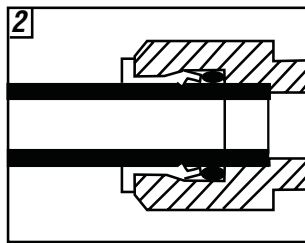

### To Release Tubing

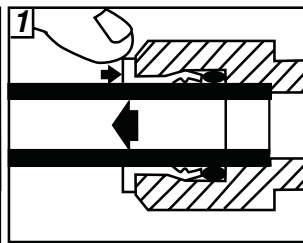

Push in grey collet to release tubing.

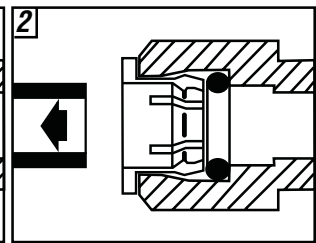

Pull tubing straight out.

Fig. 6

## M. FLUSH THE APPLIANCE OF THE PRESERVATIVE AND CHECK THE OPERATION

- 1) With the tank valve closed (the tank should still contain the sanitizing solution at this point), open the faucet (set the faucet handle in the "up" position) and feed water valve. Water should begin to drip from the faucet within several minutes. Continue to flush the system for 1 hour. Water will steadily drip from the faucet at this time. During this procedure, the tank is being intentionally bypassed in order to thoroughly sanitize the tank and also flush the membrane of any preservatives.
- 2) After flushing for 1 hour, shut off the faucet. Open the tank valve, lift the faucet handle again and allow the tank to completely empty. When the tank is empty, the faucet will drip steadily. Measure and record the rate at which water drips from the faucet. Use a graduated cylinder (in milliliters) and a watch with a second hand to calculate the approximate production in gallons per day (milliliters per minute x 0.38 = gpd). Proceed to check the reject flow by disconnecting the tubing at the drain connection and measuring the drip rate as outlined above. The ratio should be a minimum of 2.5 (reject) to 1 (product). Repeat every 5 minutes until the rate is constant. When the rate is constant, the tank is empty.
- 3) Allow the system to operate in this condition for 24 hours to ensure water purity.
- 4) Close the faucet and reinspect the appliance for leaks. Allow the tank to fill completely (it will take approximately 4 hours), then drain the tank again. **The water should be discarded** because it may contain some preservative/disinfectant solution.
- 5) The appliance should be ready to use as soon as the tank refills. If any objectionable taste is noticed after the second tankful is drained, instruct the customer to wait and drain the tank the following day. Only at this time should an icemaker be turned on if one is connected to the appliance.

**NOTE:** If an optional percent rejection (PR) monitor is used and the red light is on, service is required. Several tankfuls of water may have to be used to completely flush the excess TDS from the new carbon postfilter before a green light will show.

## N. CLEAN UP AND PAPERWORK

- 1) Clean up the work area thoroughly.
- 2) Fill out the warranty card and return it.

For replacement parts and filters, please contact your dealer or call Water Factory Systems at 1-800-733-1199 or visit our website at [www.waterfactorysystems.com](http://www.waterfactorysystems.com).

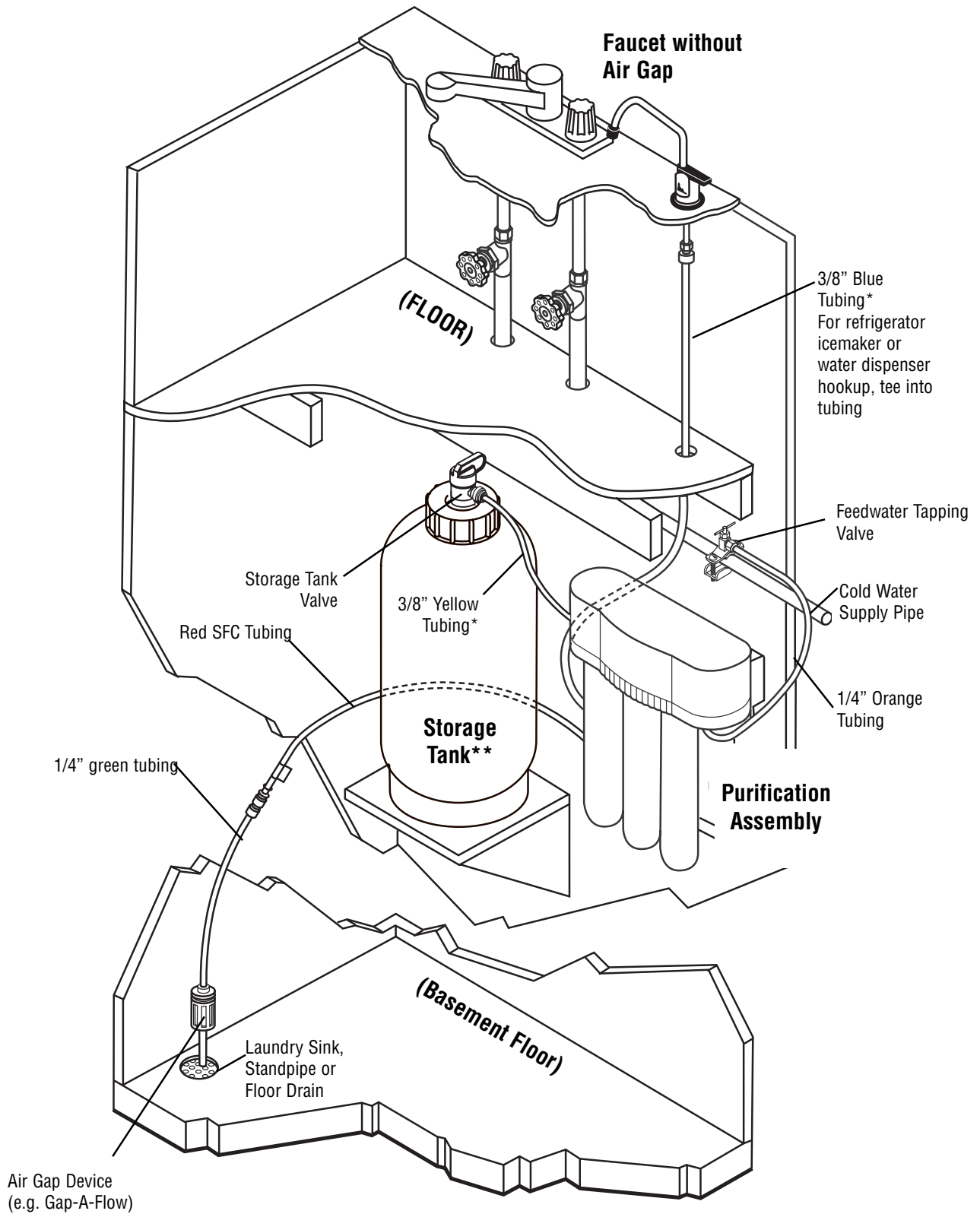

Fig. 7

## 0. APPENDIX FOR BASEMENT INSTALLATIONS

The following variations are generally required for basement installations:

### INSTALL THE DRAIN CONNECTION

For basement installations, the drain saddle is generally not used. Instead, the RO reject line (SFC tubing) is routed so that it drains into a laundry sink, floor drain, or standpipe through an approved air gap.

### MOUNT THE FAUCET

If you choose to use the air gap faucet included with the RO system, follow the faucet installation instructions given earlier in this manual. Do not hook up any air gap tubing to the faucet since an alternate air gap will be used elsewhere in the drain line.

If you choose to use the optional non-air gap faucet, follow the instructions below.

- A) Familiarize yourself with all of the components shown in the diagram of the non-air gap faucet. (See Fig. 2)
- B) Install only the chrome base plate and rubber sealing washer onto the threaded nipple. (Plumbers' putty may be used in place of the sealing washer for a neater appearance.)
- C) Feed the threaded nipple through the sink/countertop mounting hole (a 9/16" hole is adequate).
- D) From underneath the sink/countertop, install the plastic bottom washer, flat washer, star washer, and hex nut onto the threaded nipple. Hand tighten the hex nut until the faucet feels snug.
- E) After rechecking the faucet orientation, tighten the hex nut with a 9/16" wrench until the faucet feels secure.
- F) From above the sink, make any minor orientation corrections by turning the faucet on its "flats" with a padded adjustable wrench. Use care so as not to mar the chrome finish.

### INSTALL THE PURIFICATION ASSEMBLY AND THE STORAGE TANK

The purification assembly is generally mounted to the basement wall (using wall anchors) or to the wood ceiling supports. To mount the purification assembly, keep the bracket level and mark the location of the mounting holes. Install wall anchors and/or mounting screws as required. Leave the screw heads protruding to allow the bracket mounting slots to slide over them. (See Fig. 7)

The tank may be oriented either vertically or horizontally and can be placed on a shelf, on the floor, or suspended from the ceiling supports using brackets.

An effort should be made to minimize the distance between the tank and purification assembly in order to ensure an adequate flow rate to the faucet. For horizontal positioning on a shelf or floor, carefully detach the tank base from the bottom of tank and use it as a cradle.

### MAKE THE TUBING CONNECTIONS

- 1) A proper length of the 1/4" orange feed water tubing should already have been connected to the feed water tapping valve. Route it through the large opening in the bottom of the metal bracket and loop it back to the "FEED" connection on the purification assembly.
- 2) Thread the taped 3/8" x 1/4" elbow fitting into the tank valve. Do not over tighten.
- 3) Connect a longer length of 3/8" blue tubing (not included) to the faucet adapter. Route the tubing through the floor to the location of the purification assembly. Remove the existing 3/8" blue tubing from the purification assembly. Route the other end of the longer length of 3/8" blue tubing through the large opening in the bottom of the metal bracket and connect it to the "FAUCET" connection on the purification assembly.

**NOTE:** Instead of removing the existing 3/8" blue tubing from the purification assembly, a 3/8" connector fitting can be used to join the tubing from the faucet with the tubing from the purification assembly.

- 4) Route the 3/8" yellow tubing from the purification assembly to the storage tank.
- 5) Route 1/4" tubing from an appropriate drain connection (e.g. laundry sink, floor drain, standpipe) to the location of the purification assembly. An air gap must be provided between the outlet and the drain connection.
- 6) Connect the red SFC tubing from the purification assembly to the 1/4" tubing from the drain connection using the 1/4" connector fitting on the end of the SFC tubing.

## P. INSTALLATION TROUBLESHOOTING

**Problem: Leak at the feed water tapping valve.**

**Cause:** Tapping valve is not clamped tightly enough.

**Solution:** Tighten the tapping valve clamp screws evenly and firmly keeping both halves of the bracket parallel. Be sure not to deform tubing.

**Problem: Leak at the drain saddle.**

**Cause:** Drain saddle not clamped tightly enough.

**Solution:** Tighten the drain saddle screws evenly and firmly.

**Problem: Leak at the fittings threaded connection.**

**Cause:** Fitting is improperly taped or not tightened sufficiently.

**Solution:** Retape the threaded portion with Teflon® tape and thread it in firmly. Do not over tighten.

**Problem: Leak at the fitting's push-in connection.**

**Cause:** Tubing is defective if there is a tubing misassembly.

**Solution:** Remove the tubing. Squarely cut off 1/4 inch from the end of the tubing using a sharp razor knife and reinsert it into the fitting. Make sure that the tubing is pushed in completely until it seats.

**Problem: Leak at the filter cartridge head.**

**Cause:** Defective or misaligned O-ring.

**Solution:** Close the feed water tapping valve and the storage tank valve. Lift up on the faucet handle and drain the tank a minimum of 5 minutes. Remove the filter cartridge and check the condition of the O-rings. If they are misaligned, reseal them. If they are damaged, replace them.

**Problem: The faucet leaks from the spout with the handle down.**

**Cause:** An obstructed or defective valve seat in the faucet mechanism.

**Solution:** Remove the faucet spout with a twisting/lifting motion and slide the faucet handle forward over the spout hole to gain access to the faucet valve. Unscrew the tee-bar and the slotted bushing to remove the valve. Clean out any obstruction or replace it with a new valve mechanism if necessary.

**Problem: No steady drip from the open faucet after the tank is drained.**

**Causes:**

- The feed water tapping valve is not open.
- The feed water tapping valve is not installed properly.
- A leak from any product water fitting connection.
- The icemaker valve was left open before the start-up procedure completed.
- Air is still trapped in the system.

**Solutions:**

- Open the feed water tapping valve completely.
- Check the feed water tapping valve installation to make sure that the needle has pierced the tubing.
- Correct the fitting leak as outlined above.
- Close the icemaker valve and wait until the faucet drips.
- Wait for the air to be purged from the system.

**Problem: Water leaks from air gap module opening.**

**Causes:**

- The drain line tubing is looped, kinked, or has a low spot.
- The drain line is blocked or the drain hole is not drilled through completely.
- Air is locked in the air gap outlet.
- There is excessive RO reject flow.

**Solutions:**

- Trim any excess tubing to obtain a short, "straight-shot" to the drain.
- Check to see that the drain line is clear of any obstruction and remove the drain saddle fitting to verify that the hole is drilled through completely.
- Blow air into the air gap outlet using a short length of tubing.
- Disconnect the red SFC reject tubing from the faucet air gap inlet tubing and check the reject flow rate. It should be less than 175 ml/min. If it is greater than 175 ml/min., replace the red SFC reject tubing with the new one of proper length.

**Problem: Too little or no reject flow.**

**Causes:**

- Red SFC reject tubing is plugged or defective.
- The feed water tapping valve is not open.
- An obstruction in the faucet air gap module.

**Solutions:**

- Replace the SFC reject tubing with one of proper length.
- Open the feed water tapping valve completely.
- Remove the air gap module and inspect the internal flow path. Replace the air gap module if necessary.

**Problem: Chlorine or other unpleasant taste/odor is evident after the initial tank filling.**

**Cause:** Residual preservative/sanitizer is still in the water.

**Solution:** Drain and fill the storage tank several times if necessary.

**Problem: Noise in the drain (gurgling or dribbling sound).**

**Cause:** The reject water is dripping into the standing water in the drain trap.

**Solutions:**

- Make sure that the 3/8" black drain tubing from the faucet air gap module slopes continuously downward to the drain saddle without any loops or low spots.
- Angle the drain piping so that the reject water runs down the side of the drain pipe.
- Change the location of the drain saddle to the horizontal drain pipe or any alternate vertical drain pipe which is farther from the trap. Properly plug the original hole.  
**Caution:** Make sure the drain saddle is always installed above (before) the trap.

# II. Operation & Maintenance Instructions

## A. IMPORTANT WATER QUALITY ASSURANCE REQUIREMENTS

Reverse Osmosis drinking water appliances contain treatment components that are critical for the effective reduction of Total Dissolved Solids (TDS) as well as inorganic chemical contaminants. Water Factory Systems® strongly recommends that the user test the water periodically (every six months minimum) to verify that the appliance is performing satisfactorily. Some models have a Percent Rejection (PR) Water Quality Monitor to provide the user with a means to test the water at any time. If a PR Monitor is not used, your dealer will offer a bi-annual water testing service. Routine maintenance is necessary in the form of prefilter, postfilter, and membrane replacement, based on the following guidelines:

- Sediment, Carbon, or Sediment/Carbon Prefilters, and Carbon Postfilters: Change every six months to one year depending on the feed water quality.
- RO Membrane: Change it as required based on a built-in Percent Rejection (PR) Water Quality Monitor. A bi-annual testing service will be offered by your dealer if a (PR) Monitor is not used. The recommended maximum service life is 36 months.

## B. REPLACING THE FILTER CARTRIDGES

The life of the prefilter cartridge generally depends on the local water conditions (i.e., dirt, rust and/or chlorine levels) while the life of the postfilter cartridge(s) is generally determined by the length of service.

### When to Replace the Sediment or Sediment/Carbon Prefilter Cartridge(s)

- Every six months to one year, based upon your dealer's recommendation and knowledge of the local water conditions.
- A noticeable decrease in water production is an indication that the prefilter requires changing.
- Generally, private wells require more frequent sediment prefilter changes while softened feed water usually requires only yearly replacement.
- Recommended maximum sediment or sediment/carbon prefilter service life is one year.

### When to Replace the Carbon Prefilter Cartridge (SQC 4)

The carbon prefilter removes free chlorine from the feed water supply to protect the TFCM membrane from chlorine attack. To find out the chlorine level in a water supply, call the public water supplier.

- With free chlorine levels up to 1 mg/L, the carbon prefilter should be changed every year.
- With free chlorine levels exceeding 1 mg/L, the carbon prefilter should be changed every six months.

### When to Replace the Carbon Postfilter Cartridge

- If the filter is being used to control tastes and odors, replace it every year.
- If the filter is being used to reduce chloramines, change it every six months. For critical applications such as aquariums, base the filter change on periodic chloramine (combined chlorine) tests.
- If the filter is being used to meet standards for a regulated organic chemical contaminant, then cartridge replacement should be based on a monitoring program established with a public health agency.

### How to Replace the Prefilter and Postfilter Cartridges

- 1) Lift up on the faucet handle to drain the tank. Close the feed water tapping valve. Wait five (5) minutes for the purification assembly to completely depressurize.
- 2) Twist the filter cartridge 1/4 turn clockwise so that the ears on the cartridge are able to disengage from the head. Firmly pull the cartridge from the head. It may be necessary to twist the cartridge slightly from side to side to help free it. (See Fig. 8)
- 3) Remove the new filter cartridge from its sanitary sealed wrapper. (Double check to see that it is the correct replacement by comparing the labels.)
- 4) Using tap water, food grade silicone lubricant or glycerin, wet the o-ring seals to make cartridge insertion easier.
- 5) Line up the cartridge ears, insert the cartridge and push it into the head until it is fully seated. Twist the cartridge 1/4 turn counterclockwise to lock it into place.
- 6) Open the feed water tapping valve and carefully check for leaks.

## C. REPLACING THE RO MEMBRANE CARTRIDGE

The life of the RO membrane cartridge depends on the local water conditions and proper maintenance, e.g., regular filter changes. Under typical conditions, the RO membrane life ranges from 18-36 months. Unlike the filter cartridges, the RO membrane cartridge life is not determined by the amount of water used because of its self-cleaning feature.

### When to Replace the RO Membrane Cartridge

- As determined by a built-in percent rejection (PR) monitor: The monitor is factory preset so that a green light will be displayed when the water quality is good, and a red or yellow light indicates that cartridge replacement may be necessary. If a red or yellow light is displayed, the faucet should be opened and the storage tank drained. After it has refilled, check the water quality again. If a red or yellow light is still displayed, the membrane should be replaced.
- If a PR monitor is not used, your dealer or supplier will offer a bi-annual testing service.

### How to Replace the RO Membrane Cartridge

- Close the feed water tapping valve. Lift up on the faucet handle to drain the tank. Wait five (5) minutes for the purification assembly to completely depressurize.
- Make sure that there is some slack in the red SFC tubing connected to the fitting at the bottom of the RO membrane cartridge. Twist the cartridge 1/4 turn clockwise so that the tubing connection is accessible. (See Fig. 8)
- Remove the red SFC tubing by depressing the small gray collet and pulling the tubing away from the fitting.

**Note:** It is advisable to check the end of the red SFC tubing for nicks or scratches. If any are observed, cut off 1/4" from the end of the tubing with a sharp razor knife.

- Firmly pull the cartridge away from the head. (It may be necessary to twist the cartridge slightly from side to side.)
- Remove the new RO membrane cartridge from its sanitary sealed wrapper. (Double check to see that it is the correct replacement by comparing the labels.) Rinse it with tap water and dry it off.
- Remove the white plug from the fitting at the bottom of the cartridge by pushing in the small gray collet and pulling out the plug.
- Remove the red plastic cap from the top of the cartridge.
- Using tap water, food grade silicone lubricant or glycerin, wet the O-ring seals to make cartridge insertion easier.
- Reconnect the red SFC reject tubing by inserting it into the fitting at the bottom of the new RO membrane cartridge as far as it will go. Line up the cartridge ears, insert the cartridge and push it into the head until it is fully seated. Twist the cartridge 1/4 turn counterclockwise to lock it into place.
- Open the feed water tapping valve and carefully check for leaks. Carefully inspect the fitting at the bottom of the new RO membrane cartridge.
- Follow the sanitizing procedure for the storage tank and the purification assembly outlined below.

## D. SANITIZING THE RO APPLIANCE

To assure the highest quality water from your Water Factory Systems RO Drinking Water Appliance, it is important to routinely sanitize both the storage tank and the purification assembly.

**IMPORTANT:** These procedures are only intended to be part of a routine maintenance program only and are not designed to sanitize systems that have become highly contaminated from misuse.

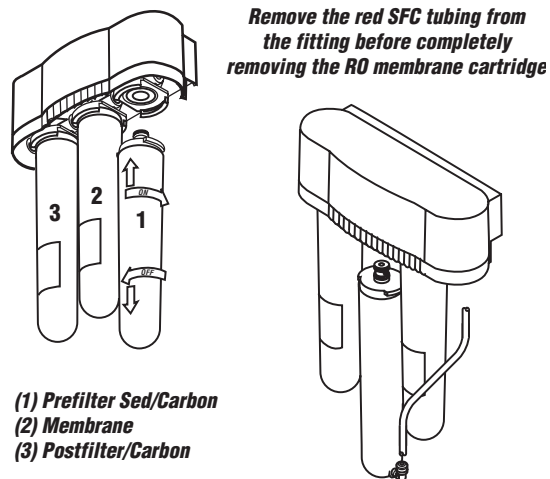

Fig. 8

### When to Sanitize the Storage Tank

- Upon start-up as described in the beginning of this manual.
- After any servicing or routine maintenance which involves the RO membrane cartridge, postfilter cartridge(s), storage tank, or faucet.

### When to Sanitize the Purification Assembly

- After any servicing or routine maintenance which involves the prefilter cartridge or the RO membrane cartridge.
- After any extended period of non-use (over 30 days) unless the cartridges are stored inside a sealed plastic bag in the refrigerator.

### How to Sanitize the Storage Tank

Sanitizing the storage tank generally requires:

- The Water Factory Tank Sanitizing Unit (P/N 50-011) or an equivalent device such as an empty filter housing with fittings and tubing.
- Common household bleach (5.25% non-scented).
- A measuring spoon or a 0-10 ml graduated cylinder.

- 1) Close the feed water tapping valve and lift up on the faucet handle to empty the water in the storage tank. It should feel light when empty.
- 2) Shut off the faucet and close the valve at the top of tank. Disconnect the 3/8" yellow tubing from the back for the purification assembly. (Refer to Fig. 6 on the use of the special "Push-In" connectors.) Remove the tank from its location and drain it into the sink by turning it upside down and opening the valve. Make sure that the outlet fitting is pointing away from your face and into the sink.
- 3) Make sure that the feed water tapping valve is completely closed and disconnect the 1/4" orange feed water tubing from the purification assembly. Connect the end of the feed water tubing to the sanitizing device. Connect an extra length of 1/4" tubing to the other end of the sanitizing device. Using the 3/8" x 1/4" union connector, connect the 3/8" yellow tubing from the tank valve fitting to the extra piece of 1/4" tubing. (See Fig. 9)
- 4) Fill the sanitizing device with the following recommended dosage of common household bleach:
  - A standard 2.5 gallon tank - 1/2 teaspoon (3 ml)
  - Alternate size tanks - 1/2 teaspoon (3 ml) per 2.5 gallons of tank capacity
- 5) Open the feed water tapping valve to force water and sanitizer into the storage tank. Allow about three (3) minutes to fill a standard 2.5 gallon tank. It should feel heavy when it is full.
- 6) The sanitizing agent should remain in the storage tank a minimum of 15 minutes. Close the feed water tapping valve and the storage tank valve. Disconnect the sanitizing device from the storage tank and feed water tapping valve. Reinstall the storage tank and reconnect the 1/4" orange feed water tubing and the 3/8" yellow tubing.
- 7) Open the feed water tapping valve to pressurize the system. Open the tank valve and lift up on the faucet handle to drain the storage tank of the sanitizing solution. When the storage tank is empty, the faucet should drip steadily.
- 8) Shut off the faucet and allow the storage tank to fill for at least six (6) hours. Drain the storage tank again and discard the water. The appliance should be ready to use as soon as the tank refills. If any objectionable taste is noticed, then drain the storage tank again and allow it to refill.

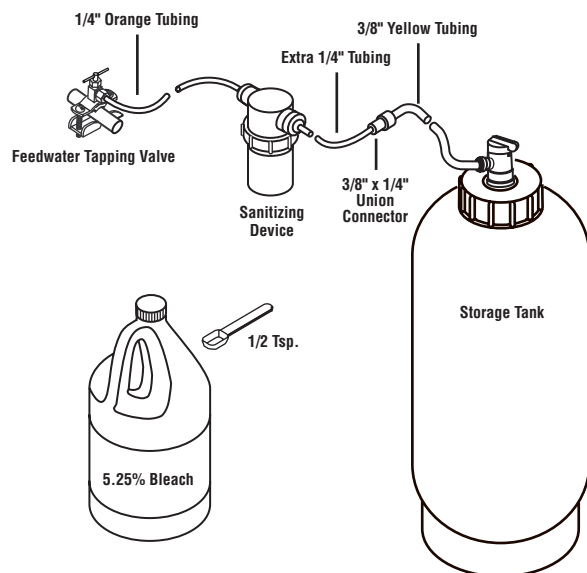

Fig. 9

### How to Sanitize the Purification Assembly

Sanitizing the Purification Assembly generally requires:

- A new prefilter cartridge
- Common household bleach (5.25% non-scented)
- A standard eyedropper or equivalent

- 1) Close the feed water tapping valve and lift up on the faucet handle to empty the storage tank.
- 2) Follow the instructions on changing the prefilter cartridge.
- 3) Before installing the new cartridge, use an eyedropper to inject one teaspoonful (approximately 5 ml) of household bleach into the center opening of the filter cartridge. The prefilter is located just before the RO membrane cartridge. (See Fig. 10)
- 4) Open the feed water tapping valve and allow the appliance to operate for at least six (6) hours. Drain the storage tank and discard the water. The appliance should be ready to use as soon as the storage tank refills. If any objectionable taste is noticed, then drain the storage tank again and allow it to refill.

### E. LONG TERM NON-USE

If the RO appliance is to be left unused for a long period of time (greater than 30 days), follow this procedure:

- 1) Lift up on the faucet handle to drain the storage tank and close the feed water tapping valve. Wait five minutes for the purification assembly to depressurize.
- 2) Remove all of the filter cartridges. Turn the cartridges upside down in the sink to drain out as much water from them as possible.
- 3) Place the cartridges in an air tight plastic bag and store them in the refrigerator. **Important: The cartridges must be not be allowed to freeze because permanent damage may occur.**
- 4) When the RO appliance is ready to be put back into service, reinstall the filter cartridges by matching the symbols on the top of the cartridge labels with the ones on the purification assembly heads. Sanitize the storage tank as described in the previous section. The purification assembly can be sanitized at this time if so desired.
- 5) Follow the start up procedure outlined in the previous section.

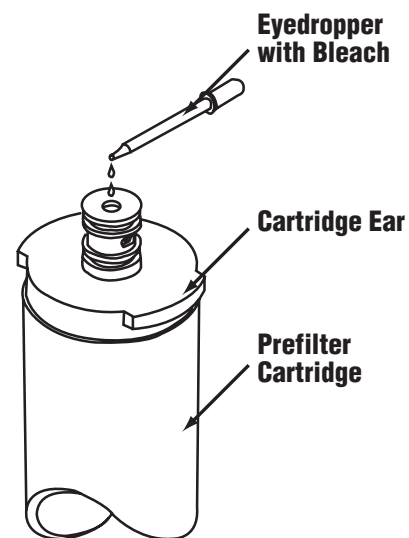

Fig. 10





---

**CUNO Incorporated**

400 Research Parkway

Meriden, CT 06450, U.S.A.

Toll Free: 1-800-733-1199

Worldwide: 203-237-5541

Fax: 203-238-8701

[www.waterfactorysystems.com](http://www.waterfactorysystems.com) • [www.cuno.com](http://www.cuno.com)