

# MARK 4 10-BUTTON POST MIX MANIFOLD

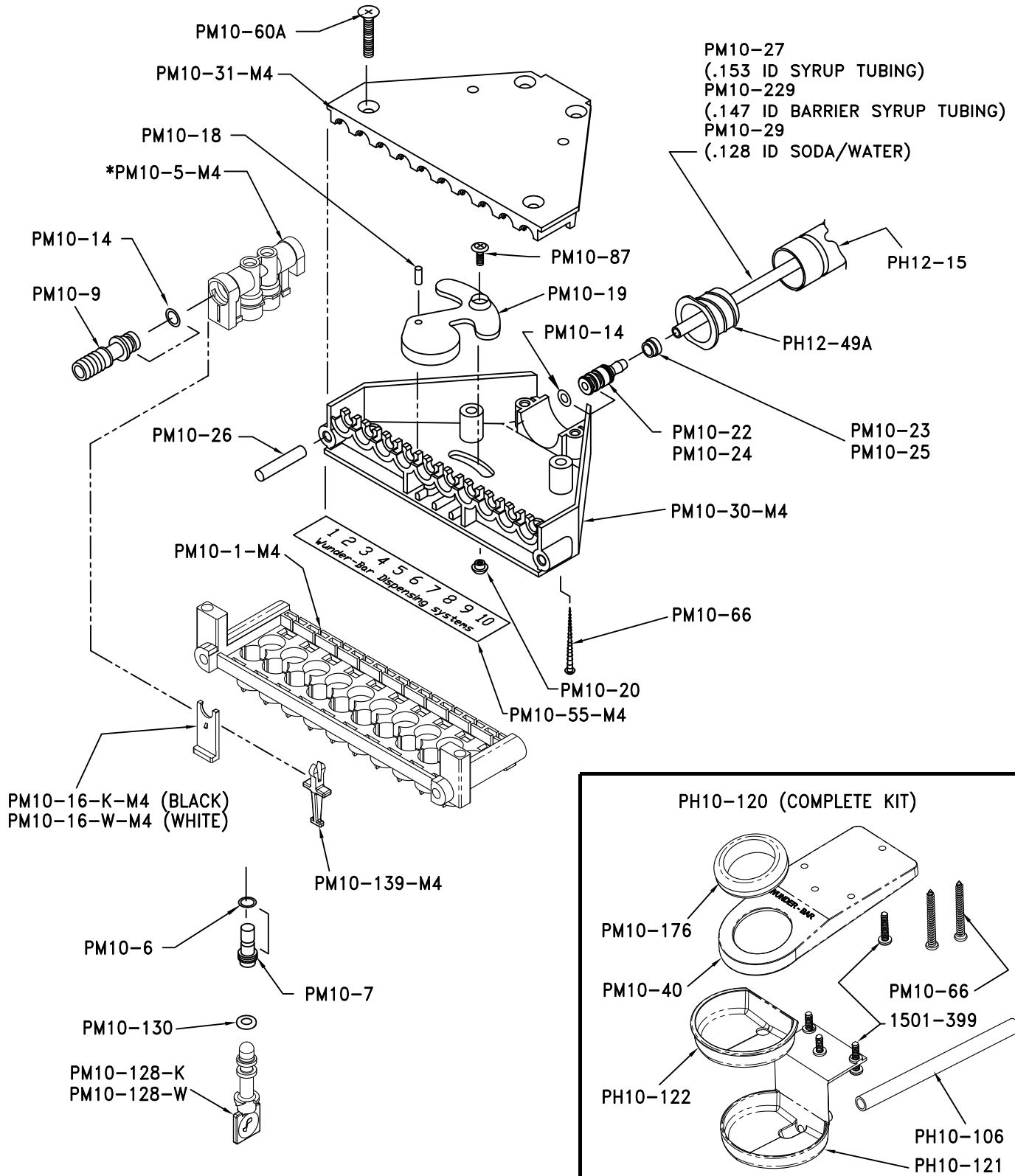

\*NEEDS TO BE ORDERED AS PM10-5-M4-C

## Wunder-Bar™

AUTOMATIC BAR CONTROLS, INC.  
2060 CESSNA DR, SUITE 100  
VACAVILLE, CA 95688

www.wunderbar.com

PHONE: (707) 448-5151  
FAX : (707) 448-1521